

Pos. Nr. Pos. no.	Beschreibung Description	Art.-Nr. Art. no.	Preisgruppe Price bracket
62709	DB BR 185.2	≡	
68709		~	
1	Motor komplett Motor assembly	85111	57
2	Stromabnehmer Pantograph	85383	39
3	FK - Schraube FK - Screw	85771	3
4	Zugfeder Spring	86202	2
5	Kardanschale Cardan bearing	87129	3
6	Distanzplättchen Spacer	106116	2
7	Brückenstecker Bridge connector	125666	12
8	Anschlag Bedstop	114651	2
9	GF - Schraube M1,6x5 GF - Screw M1,6x5	115269	2
10	Platine komplett Printed circuit assembly	123807	57
11	Stirnfenster Front window	123039	6
12	TS - Gehäuse Parts set body	131211	10
13	TS - Dachleitungen Part set roof wires	123006	12
14	Dachdeckel Roof cover	123007	6
15	Gehäuse komplett Betr. Nr. 185 323-0 Body assembly loco no. 185 323-0	131222	70
16	TS - Fenster-Lichtleitstäbe Part set window-lights transmission bar	131224	10
17	TS - Frontgriffe Part set front handrails	123013	5
18	TS - Griffstangen Part set handrails	123014	8
19	TS - Scheibenwischer Part set wipers	123016	5
20	Haltegriff seitlich Handrail on the side	123017	4
21	Schraube Screw	123018	2
22	Grundrahmen Frame	123020	36
23	TS-Führerst.+Lichtabdeckung+Lichtkasten Part set driver cab-light cover-light box	124787	11
24	Kabelhalter Cable holder	123030	3
25	Steckdosenrahmen Frame with plugs	129178	3
26	TS - Videokamera links + rechts Part set video camera left + right	131225	4
<b>AC - Wechselstrom 68709</b>			
27	Lokdecoder Motorolaastger. Decoder motorola load reg.	10732	---

Änderungen in Konstruktion und Ausführung vorbehalten  
We reserve the right to change the construction and specification

1x Batterie kasten klein o. Abb.  
1x Battery box short no ill.



19



7

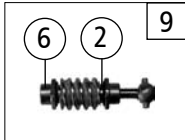

9

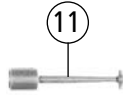

11

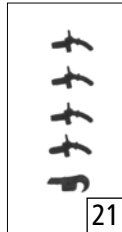

21

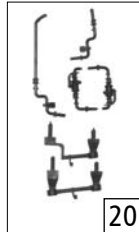

20



8

24 o. Abb. / no ill.  
Radkontakt o. Abb.  
Wheel contact no ill.

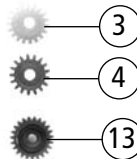

3

4

13

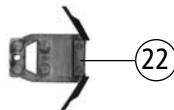

22

17

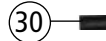

30

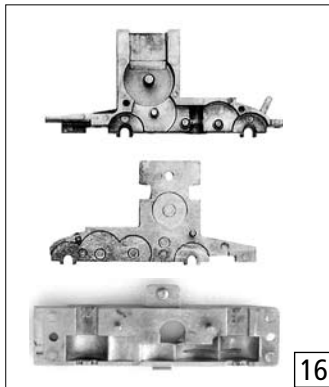

16

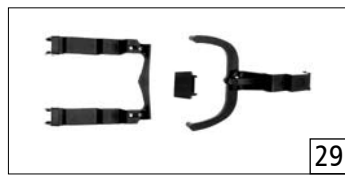

29

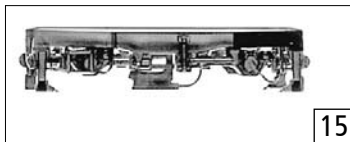

15

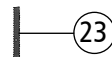

23

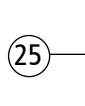

25



5



12

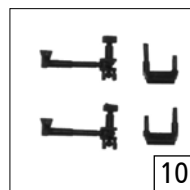

10

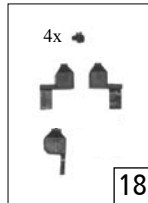

18

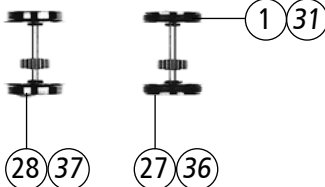

1 31

28 37

27 36



35

34 o. Abb. / no ill.  
Getriebeboden AC  
Gear bottom AC



32



33

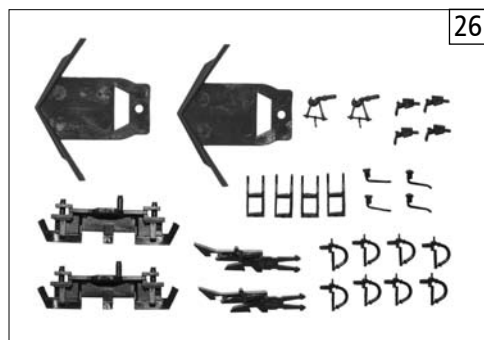

26

Pos. Nr. Pos. no.	Beschreibung Description	Art.-Nr. Art. no.	Preisgruppe Price bracket
62709	DB BR 185.2	≡	
68709		~	
1	Hafringsatz 105tk 12,9-14,6mm Set with traction tire 10pieces	40070	---
2	Beilagscheibe Washer	86108	2
3	Schneckenzahnrad gelb Worm gear yellow	86413	4
4	Zahnrad Z=17/0.4 G Gear Z=17/0.4 G	86418	2
5	Standardkupplung Standard coupling	89246	5
6	Schneckenachslager Worm axle bearing	89749	6
7	Schneckendeckel Worm cover	94707	3
8	Kontakthalterrahmen Contact holder	106765	5
9	Schneckensatz kpl. Set worm gear ass.	108022	24
10	TS - Blendesteckteile Part set push in part bogie	110138	6
11	Kardanwelle Cardan shaft	108332	3
12	Schraube M 1,6X5 Screw M 1,6X5	110008	2
13	Zahnrad Z=23 Gear Z=23	111679	2
15	Drehgestellblende kpl. Bogie frame assembly	112878	25
16	TS - Getriebe Part set gear	120055	19
17	Puffer Buffer	123003	2
18	TS - Sandbox Part set Sand boxes	123008	10
19	Werkzeugkasten+Batteriekasten klein Part set Battery box	129160	10
20	TS - Ölröhre Part set Oil pipes	123011	10
21	TS-Luftschläuche+Kupplungsimitation Part set Air hoses-Coupler imitation	123015	5
22	Schienenräumer Snow plug	123021	4
23	Schraube Screw	123022	2
24	Radkontakt o. Abb. Wheel contact no ill.	123023	3
25	Kupplungsfeder Coupler spring	123024	2
26	Zurüstbeutel Bag with accessories	131218	18
27	Radsatz m. Hafringen+Zahnrad Wheel with traction tires with gear	123043	20
28	Radsatz m. Zahnrad o. Hafring Wheel with gear without traction tires	123044	18
29	TS - Kupplung Part set Coupler	123029	7
30	Pufferhülse Buffer base	124668	2
<b>AC - Wechselstrom 68709</b>			
31	Hafringsatz 105tk 12,5-15,3mm Set with traction tire 10pieces	40075	---
32	Schraube M 1,6X5 Screw M 1,6X5	85702	2
33	Schleifer 42mm Slider 42mm	86030	----
34	Getriebeboden o. Abb. Gear bottom no ill.	113321	10
35	Radsatz o. Hafring o. Zahnrad Wheel without traction tires without gear	123049	16
36	Radsatz m. Hafringen +Zahnrad Wheel with traction tires with gear	123047	20
37	Radsatz m. Zahnrad o. Hafring Wheel with gear without tractions tires	123048	18

Ersatzteile erhalten Sie bei Ihrem Fachhändler, oder Ihrer Landesvertretung:  
You can order your Replacement Parts at your local dealer, your country representative: