

20

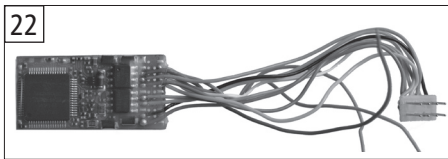

7

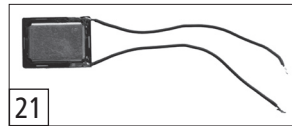
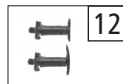
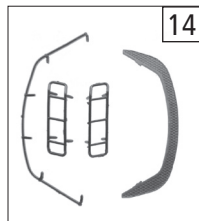
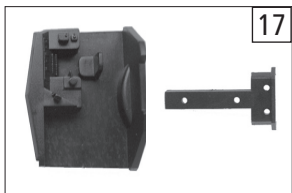
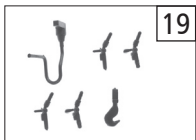
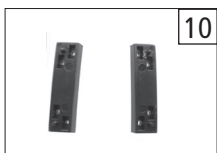
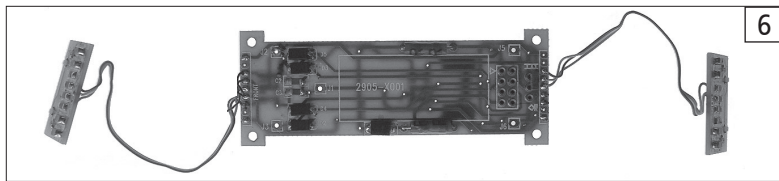

18



4

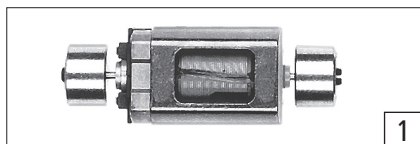

1

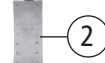

2

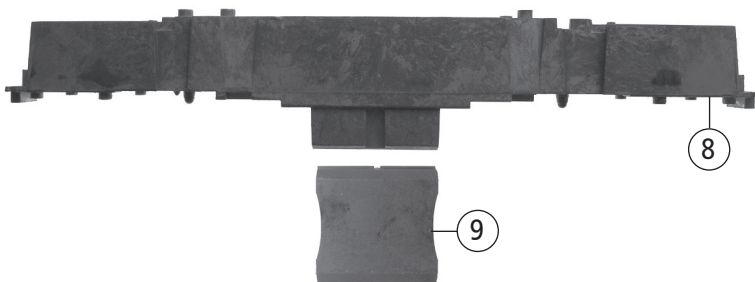

8

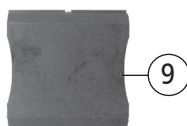

9

Pos. Nr. Pos.no.	Beschreibung Description	Art.-Nr. Art.no.	Preisgruppe Price bracket
62822	SNCB -NMBS 60	=	
62878		=	🔊
68878		~	🔊
1	Motor Motor	85111	57
2	Motordämpfer Motor attenuator	113376	3
3	Motorkontaktfeder Motor contact spring	121565	2
4	Brückenstecker mit Kondensator Connector with capacitor	125666	12
5	Gehäuse kpl. Betr.Nr. 210 003 Gehäuse kpl. Betr.Nr. 210 003	132034	68
6	Platine kpl. mit LED-Platinen Printed circuit with LED circuit	127252	55
7	Schraube M2x5 Screw M2x5	127235	3
8	Grundrahmen lackiert Base frame coated	127238	32
9	Tank Tank	127242	4
10	TS - LED - Platinenhalter Part set LED - circuit holder	127248	10
11	TS - Frontschürzen Part set front skirts for running	127254	10
12	Puffersatz Buffer set	127257	10
13	Scheibenwischersatz Wiper set	127259	5
14	TS - Gehäuse Pat set body	129866	10
15	TS - Fenster + Lichtleitern Part set window + light trans. baar	127261	20
16	Lichtblende Light cover	132036	7
17	TS - Führerstand + Lichtabdeckung Part set cabin + light cover	129865	7
18	Motordistanzplatte Motordistanzplatte	127264	4
19	Schürzensteckteile für Betrieb Part set for front skirts for running	127266	5
20	Griffstange lang Handrail long	127307	3
<b>Sound</b>			
21	Lautsprecher loud speaker	129524	30
22	Sounddecoder 88mm Sounddecoder 88mm	129600	80
23	Lautsprechergehäuse Speaker Holder	125398	3

Änderungen in Konstruktion und Ausführung vorbehalten  
We reserve the right to change the construction and specification

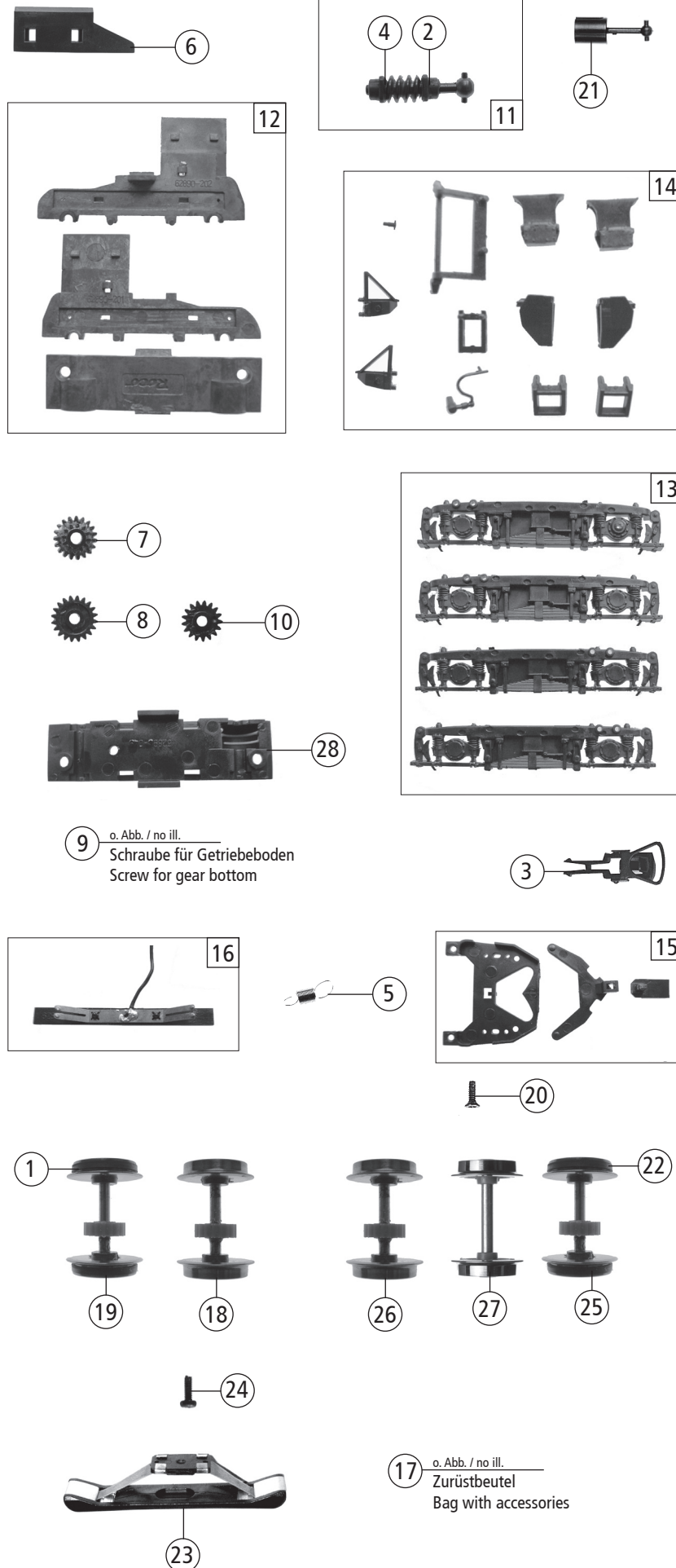

Pos. Nr. Pos.no.	Beschreibung Description	Art.-Nr. Art.no.	Preisgruppe Price bracket
62822	SNCB -NMBS 60	=	
62878		=	🔊
68878		~	🔊
1	Hafringsatz 10Stk. 10,3-12,8 Set with traction tires 10pieces	40069	---
2	Scheibe Washer	86108	2
3	Standardkupplung Standard coupling	89246	5
4	Lager für Schneckenachse Bearing for worm axle	89749	6
5	Kupplungsfeder Coupling spring	113382	2
6	Schneckendeckel Worm cover	125375	4
7	Schnecken Zahnrad Z=19/Z=12 Worm gear Z=19/Z=12	125388	4
8	Zahnrad Z=22 Gear Z=22	125389	3
9	Schraube für Getriebeboden o. Abb. Screw for gear bottom no ill.	127629	2
10	Zahnrad Z=15 Gear Z=15	127236	3
11	Schneckensatz kpl. Worm gear ass.	127237	24
12	TS - Getriebe 3-teilig Part set gear 3-parts	127239	24
13	TS - Drehgestellblenden Part set bogie	127240	20
14	TS - Fahrgestell Part set frame	127241	12
15	TS - Deichsel Part set shaft	127243	14
16	Radkontaktsatz Wheel contact set	127251	7
17	Zurüstbeutel o. Abb. Bag with accessories no ill.	127253	18
18	Radsatz m. Zahnrad o. Hafring Wheelset w. gear without traction tyre	127255	18
19	Radsatz m. Hafring m. Zahnrad Wheelset w. traction tyre w. gear	127256	20
20	Senkkopfschraube Screw	127258	3
21	Kardanwelle Cardan shaft	127265	3
<b>AC - Wechselstrom</b>			
22	Hafringsatz 10Stk. 10,3-12,4 Set with traction tires 10pieces	40074	---
23	Schleifer 42mm Slider 42mm	86030	26
24	Schraube M1,7x5 mm Schraube M1,7x5 mm	125800	2
25	Radsatz m. Hafring m. Zahnrad Wheelset w. traction tyre w. gear	127267	20
26	Radsatz m. Zahnrad o. Hafring Wheelset w. gear without traction tyre	127268	18
27	Radsatz o. Zahnrad o. Hafring Wheelset without gear without traction tyre	127269	16
28	Getriebeboden AC Gear bottom AC	127365	15