



## **English**

**Technical Information for the Mobile Station**

**3**

**Appendix**

**9**

**Table of Explanations for Functions  
on Display Screen**

**25-26**

## Upper Surface with Controls

- 1 – Speed Control Knob
- 2 – Button Locomotive/OK
- 3 – Button Menu/ESC
- 4 – On/Off Button for Headlights
- 5 – STOP-Button
- 6 – Auxiliary Function Buttons
- 7 – Graphic Display with
  - a) Auxiliary Function Indicator (up to 9 indicators)
  - b) Representation of the Locomotive Type
  - c) Locomotive Designation
  - d) Speed Indicator
  - e) Direction Indicator

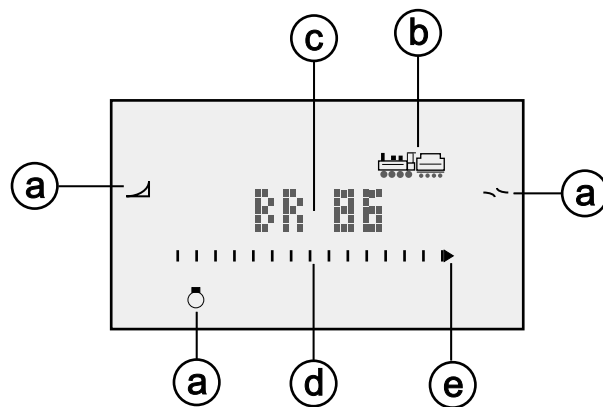
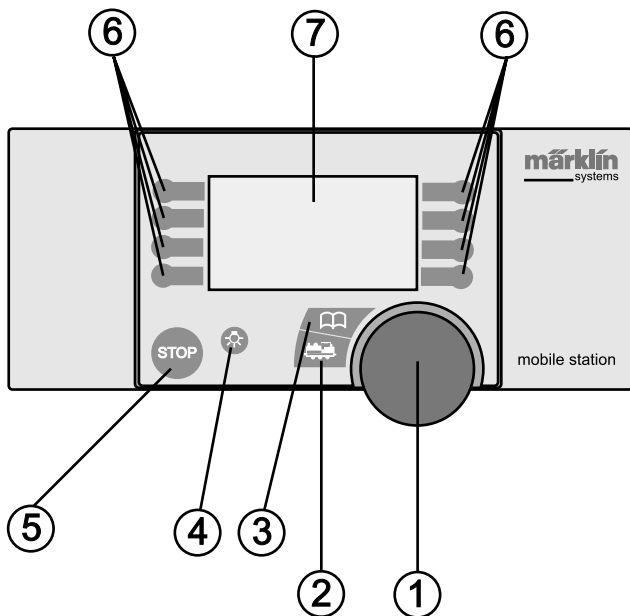

## Possible Uses for the Mobile Station

60652 individual controller, controller from 1 Gauge starter sets:

- Suitable for Märklin H0 and 1 Gauge.
- Maximum output current: 1.9 amps (with 60052 Transformer).
- Connections only by means of special connector box.
- Number on the base of the controller: "60651" (!)

Controller from Märklin H0 starter sets:

- Suitable for Märklin H0.
- Maximum output current: 1.2 amps (with 60052 Transformer).
- Connections only by means of special connector box.
- Number on the base of the controller: "60652".

The output current is sufficient for 2 – 3 locomotives in operation. The number of locomotives that can be run may be lower due to cars with interior lighting, smoke generators that are on, sound effects modules that are on, etc. The Central Station is the suitable operating system for layouts with several users. The Mobile Station can be used here as a locomotive controller.

## Connections for the Mobile Station

1. Check to make sure that the power cord(s) for the layout are unplugged from the wall outlet.
2. Check to make sure that the transformer or the power pack is the right one for your household electrical current (value of the input voltage, value of the frequency). This information can be found on the specification plate for the transformer / power pack.
3. Plug in the Mobile Station. The first Mobile Station must be connected to the left 10-pin socket on the connector box.
4. Connect the transformer or power pack to the connector box. (= > Appendix A)

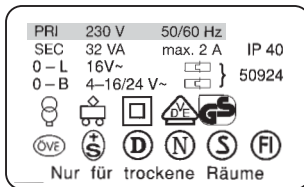

## Starting Operation

Mobile Station after the power cord for the power pack / transformer is plugged into the wall outlet:

1. Short phase while the system is being turned on ("MÄRKLIN" appears in the display).
2. Mobile Station switches directly to the operation mode. (= > Appendix B)

On the Mobile Station the locomotives to be controlled are selected from a locomotive list. Since the Mobile Station comes

from the factory with no entries in the locomotive list, the display goes directly to the entry of locomotives into the locomotive list. ("NEW LOC"). The Mobile Station that comes with the starter sets comes from the factory with entries already in its locomotive list.

## Putting a Locomotive into the Locomotive List

Possibility A: mfx locomotives automatically register themselves.

Possibility B: The locomotive is taken from the database.

Possibility C: The locomotive is entered by means of its address.

Possibility A:

Place a locomotive with a built-in mfx decoder on the track before turning the layout on. During the period in which the system is turning itself on, the mfx locomotive transfers its data to the Mobile Station. As soon as the Mobile Station is ready for operation, this locomotive can be selected from the locomotive list.

(=> Appendix C)

Important: If the locomotive list has 10 entries, then no other locomotive can be placed into the locomotive list. In this situation one entry must be deleted (= > Page 12) and then the mfx locomotive can be registered again.

Possibility B:

1. Press the Menu/ESC button.
2. Turn the speed control knob until "NEW LOC" appears in the display.
3. Press on the speed control knob.
4. Turn the speed control knob until "DATABASE" appears in the display.
5. Press on the speed control knob.
6. Turn the speed control knob until the item number for the locomotive appears in the display.
7. Press the Locomotive/OK button. The display will change back on its own to the operating level.

(=> Appendix D)

Possibility C:

1. Press the Menu/ESC button .
2. Turn the speed control knob until "NEW LOC" appears in the display.
3. Press on the speed control knob.
4. Turn the speed control knob until "ADDRESS" appears in the display.
5. Press on the speed control knob.

6. Turn the speed control knob until the address for the locomotive appears in the display.
7. Press on the speed control knob.
8. Turn the speed control knob until the desired symbol appears in the display.
9. Press the Locomotive/OK button. The display will change back on its own to the operating level.

(=> Appendix E)

Tip: The address or the name in the display can be changed for all entries in the locomotive list (Page 11/12). This means that you can change entries from the database for other applications.

## Controlling the Locomotive

Turn the speed control knob to the right  
– the locomotive goes faster.

Turn the speed control knob to the left  
– the locomotive goes slower.

The bar in the speed indicator changes with the new speed that has been set.

Press on the speed control knob – the direction of travel changes.

At the same time the direction of travel indicator and the direction of the bar in the speed indicator changes.

Pressing auxiliary function buttons

– the function assigned to that button is turned on.

Please Note:

- The auxiliary functions (if they are present in the locomotive) for locomotives from the database are shown as a graphic symbol in the display. Only these functions can be turned on.
- Headlights are mostly turned on with the separate headlight button.
- Locomotives that are set up in the locomotive list with an address have no graphic symbol in the display. In this situation the headlight button is used for the auxiliary function “function” and the 4 auxiliary function buttons to the left of the display are used for the auxiliary functions f1, f2, f3, and f4 (from top to bottom).

## Changing the Locomotive

1. Press the LOCOMOTIVE/OK button.
2. Turn the speed control knob until the desired locomotive appears in the display.
3. Press the LOCOMOTIVE/OK button.

(=> Appendix F)

Now the newly selected locomotive can be controlled. The last locomotive called up before this will continue to run with the last operating commands sent to it!

## Emergency Stop

Press the STOP button: The power is not off to the layout. All locomotives and trains will come to a halt. “STOP” will appear in the display.

Pressing the Stop button again will turn the power to the layout on again.

Important: When there is a short circuit or when the system is overloaded, the system switches to the STOP status on its own. Correct the problem in this case and try to resume operation by pressing the Stop button. If the system shuts down again, then the problem has not been corrected yet!

## Changing Locomotive Data

Requirement:

The locomotive has been entered into the locomotive list.

For locomotives with the address set by means of the Mobile Station: Only this locomotive may be in the area controlled and powered by the Mobile Station.

**No change of address is required for locomotives with an mfx decoder. As such, this setting option is not available for these products.**

## Changing the Address

1. Stop the locomotive.
2. Press the Menu/ESC button.
3. Turn the speed control knob until “EDIT LOC” appears in the display.
4. Press on the speed control knob.
5. Turn the speed control knob until “ADDRESS” appears in the display.
6. Press on the speed control knob.
7. Turn the speed control knob until the new desired address for the locomotive appears in the display.
8. Press on the speed control knob.

On locomotives with coding switches, the new desired address must be set on the decoder.

(=> Appendix G)

The following only applies to locomotives, whose address can be set with the Mobile Station:

9. The question “PROG LOC?” will appear in the display. Press the Menu/ESC button: The address is only changed in the locomotive entry. Press on the speed control knob: The locomotive address is changed according to the data transmission.

(=> Appendix H)

Important: Point 9 only works if the locomotive is ready for it, when the locomotive is being powered by the Mobile Station, the locomotive has perfect electrical contact, and no other locomotives are in the area of track being powered by this Mobile Station.

## Changing the Designation in the Display

Requirement: The locomotive data to be changed are shown in the display.

1. Press the Menu/ESC button.
2. Turn the speed control knob until "EDIT LOC" appears in the display.
3. Press on the speed control knob.
4. Turn the speed control knob until "NAME" appears in the display.
5. Press on the speed control knob.
6. Turn the speed control knob and change the first letter in the process.
7. A Press on the speed control knob. Now the 2nd letter can be turned by running the speed control knob.
8. Continue with the following commands:

Pressing on the speed control knob: Moves one position forward.

Pressing the Menu/ESC button: Moves one position back.

Pressing the LOCOMOTIVE/OK button: Accepts the new designation.

(=> Appendix I)

Maximum recommended length for a designation: 10 letters.

Tip: Letters can be deleted by overwriting them with another character. BLANK spaces ("•") at the end of the entry are automatically deleted when the entry is applied.

## Deleting a Locomotive from the Locomotive List

Requirement: Speed Level = 0 (locomotive stopped)

1. Press the LOCOMOTIVE/OK button.
2. Turn the speed control knob until the locomotive to be deleted appears in the display.
3. Press the LOCOMOTIVE/OK button.
4. Press the Menu/ESC button.
5. Turn the speed control knob until "DELETE LOC" appears in the display.
6. Pressing on the speed control knob. The confirmation question "DELETE LOC?" will appear in the display.
7. Exit by pressing on the LOCOMOTIVE/OK button.

(=> Appendix J)

## OPTIONS

The language version can be set in this area, and the entire Mobile Station can be returned to the default settings. The sub-menu "INFO" is only the Märklin Service Department for repairs and is not set up for end users.

## Language Version

Languages that can be set: German, English, French, Dutch

1. Press the Menu/ESC button.
2. Turn the speed control knob until "SETUP" appears in the display.
3. Press on the speed control knob.
4. Turn the speed control knob until "LANGUAGE" appears in the display.
5. Press on the speed control knob.
6. Turn the speed control knob until the desired language appears in the display.
7. Press the LOCOMOTIVE/OK button.

(=> Appendix K)

## PRESET

Important: When a PRESET is carried out of all of the locomotive data in the list (including changes / address, name) are lost! With a Mobile Station from a starter set, the data set at the factory for the locomotive(s) from the starter set are written into the list again, when a PRESET is carried out.

1. Press the Menu/ESC button.
2. Turn the speed control knob until "SETUP" appears in the display.
3. Press on the speed control knob.
4. Turn the speed control knob until "PRESET" appears in the display.
5. Press on the speed control knob.
6. The confirmation question "PRESET?" will appear in the display. Pressing the LOCOMOTIVE/OK button: Reset is carried out. Pressing the Menu/ESC button several times will return you to the main operation level without the Reset being carried out.

**Important: If you press the STOP button and the speed control knob simultaneously for longer than 1 second when turning on the power supply to the Mobile Station, this will cause a PRESET without a safety inquiry to be carried out directly!**

## Setting Other Locomotive Parameters

The setting only works with mfx locomotives or locomotives with a decoder that can be set with data. In some cases, these decoders only have some of the following possibilities for setting parameters.

Possible Settings:

- VMAX – Maximum Speed
- ACC – Acceleration
- DEC – Braking Delay
- VOL – Volume
- PRESET – Return the locomotive decoder to the factory default data

Important: Do not confuse the “PRESET” for the locomotive decoder (submenu EDIT LOC) with the “PRESET” for the Mobile Station (submenu OPTIONS).

1. Press the Menu/ESC button.
2. Turn the speed control knob until “EDIT LOC” appears in the display.
3. Press on the speed control knob.
4. Turn the speed control knob until “VMAX”, “ACC”, “DEC”, “VOL” or “PRESET” (depending on the desired change) appear in the display.
5. Press on the speed control knob.
6. The menu symbol will appear in the display and a setting bar beneath it. Turn the setting bar on the speed control knob without changes. Small bar: lower maximum speed, shorter delay, etc., a longer bar means the opposite of the various values.
7. Press on the speed control knob to accept the new setting. Under no circumstances is the power supply to be interrupted in the period of time that comes after this (“PROG” in the display). (=> Appendix M)

Difference in the submenu RESET starting at Step 6.

6. The confirmation question “PRESET?” will appear in the display. Press on the speed control knob: PRESET is carried out. Under no circumstances is the power supply to be interrupted in the period of time that comes after this (“PROG” in the display).

## Using a Second Mobile Station

A second Mobile Station can only be connected to the system with an adapter cable (item no. 610 479). The connection socket for the second Mobile Station is the center socket on the connector box.

Important: Technical designation for the main controller (left socket): Master

Designation for the second controller: Slave

Connections: => Appendix N

After the system is turned on:

- The second controller receives data from the main controller (locomotive list). The second controller’s locomotive list cannot be accessed in this situation.
- The second controller is shown in the display with a symbol.
- A locomotive already in use by one controller cannot be called up on another controller.
- No operation is possible with a Master controller.
- Always use the Mobile Station with the greater output current (1.9 amps instead of 1.2 amps) as the master controller.
- **Never use several 24088 feeder tracks or 60115 connector boxes.**

**Caution: No external voltage ever must be applied to the track to which the Mobile Station is connected. As such, it is not permitted to install a junction point to another operating system (alternating voltage, Märklin Digital etc.).**

(=> Appendix O)

**Caution: The transformer for the Mobile Station may not be used to simultaneously power accessory articles. These require a separate transformer.**

## Error Display

Indication	Description	What to do
ADDR.USED	Locomotive address identical with another entry in the locomotive list. In this situation the locomotive is present in the locomotive list but without any possibility of accessing it.	– Change address. – Delete locomotive from the locomotive list.
LIST FULL	The locomotive list has the maximum number of entries.	– Delete locomotive(s) from the locomotive list.
LOC USED	The desired function (example: deleting a locomotive from the locomotive list) can not be done, since the locomotive still has an operating command greater than 0.	– Return to the operating level and stop the locomotive.

## Technical Information for the Mobile Station

### **Do not expose the Mobile Station to moisture.**

This Märklin product is not waterproof. It can malfunction in the presence of high levels of humidity or if water gets into the housing. The corrosion of the internal moving parts and of the electronic circuit can lead to irreparable damages.

### **Do not expose the Mobile Station to vibration.**

If this unit is exposed to blows or strong vibration, it can lead to ongoing malfunctions.

### **Do not expose the Mobile Station to extremes of temperature.**

Moisture can condense inside the housing due to sudden changes in temperature. In order to avoid a buildup of water from condensation, you should maintain and transport the Mobile Station so that it is protected, before you change to a location with a clearly higher or lower temperature.

### **Handle the moving parts with caution.**

Do not use force when operating the buttons and the speed control knob on the Mobile Station.

## Safekeeping

Do not keep the Mobile Station in locations, where the following unfavorable conditions are prevalent:

- High levels of humidity or bad ventilation.
- Temperatures over 50° Centigrade / 122° Fahrenheit (such temperatures can occur near heaters or in direct sunlight) or under -10° Centigrade / 14° Fahrenheit.
- Humidity over 60%.

### **Avoid any contact with crystalline liquids.**

In the event that the display is damaged (example: breakage) there is the damage that you can become injured from glass slivers or that the crystalline liquids from the display will come out. Be very careful that your skin, eyes, and mouth do not come into contact with the crystalline liquids.

## Cleaning

Remove lint and dust with a soft, dry, or light moistened cloth.

**Never use alcohol, thinner, or other strong cleansers.**



# Appendix

## A

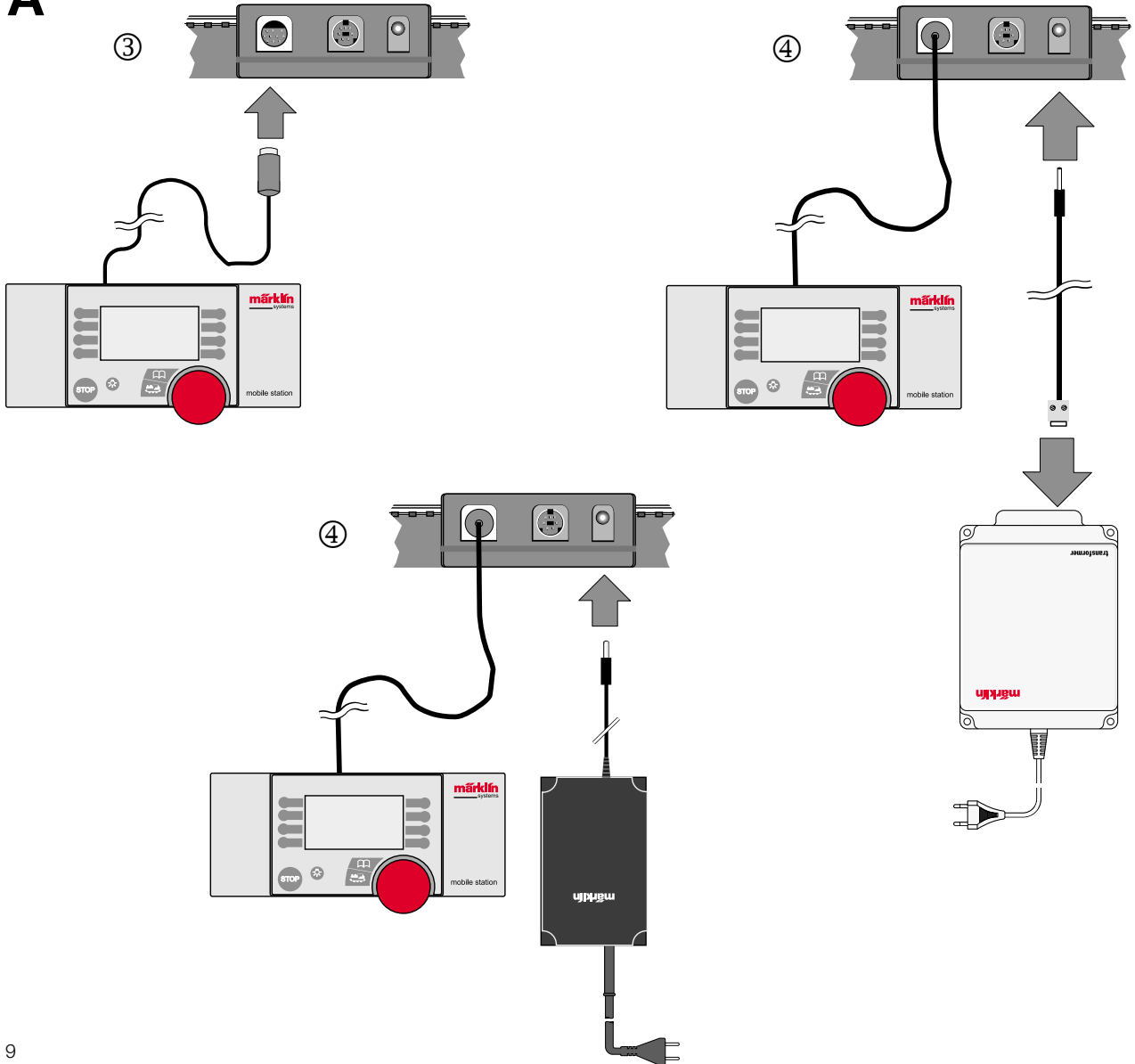

# Appendix

## A

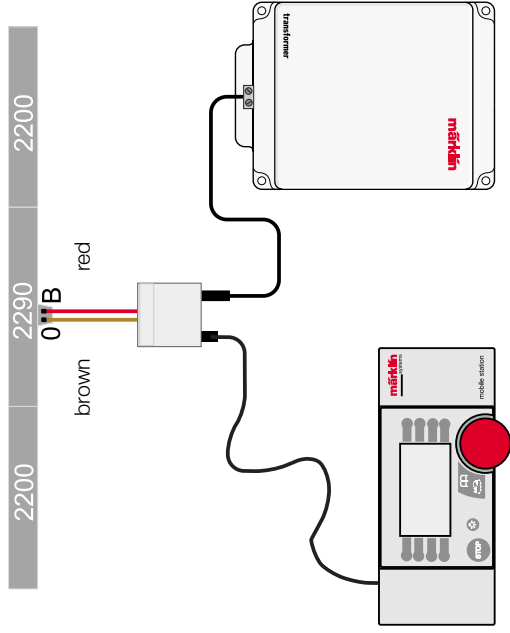
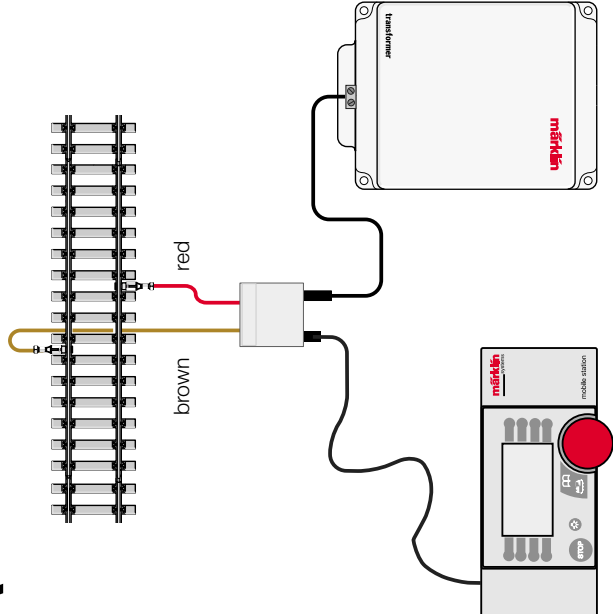

# Appendix

## B

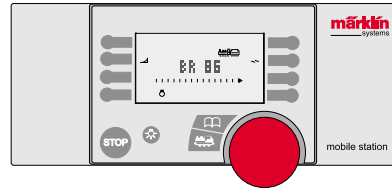
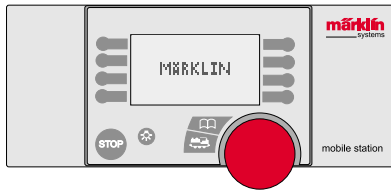

## C

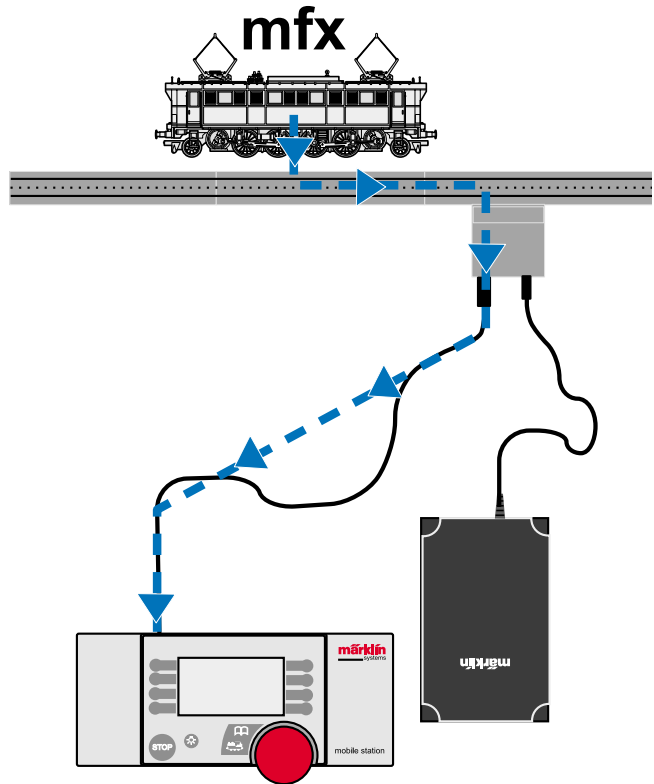

# Appendix

## D



# Appendix

## E

①

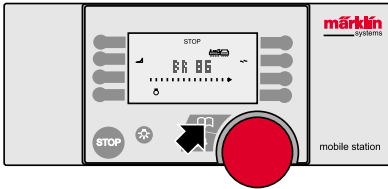

②

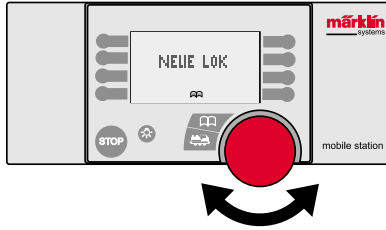

③

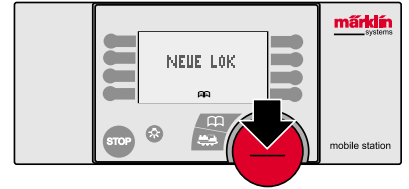

④

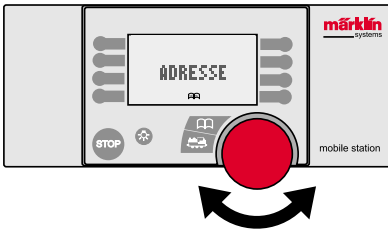

⑤



⑥

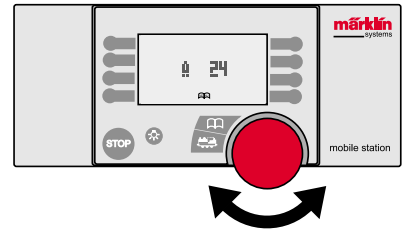

⑦

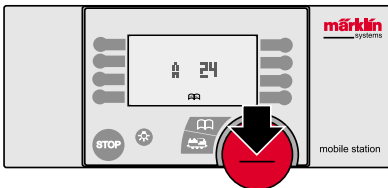

⑧

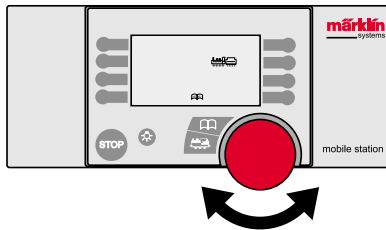

⑨

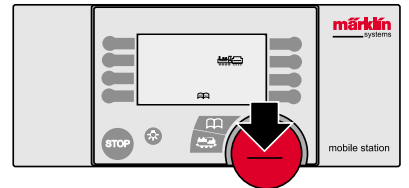

# Appendix

# F

①

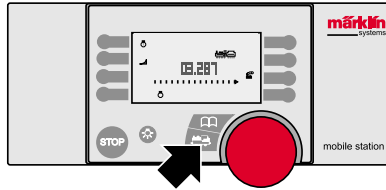

②

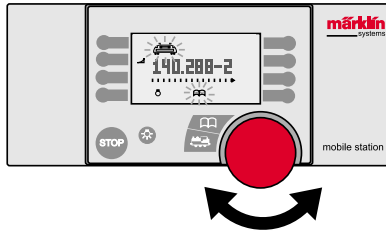

③

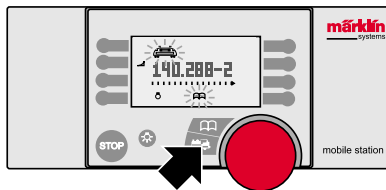

# Appendix

## G

②

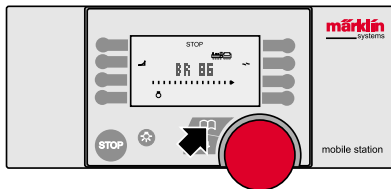

③

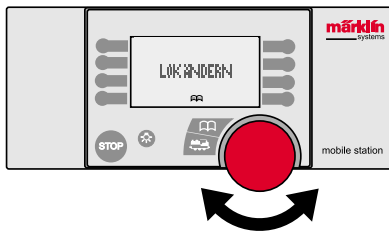

④

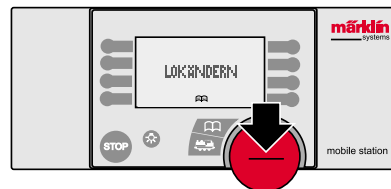

⑤

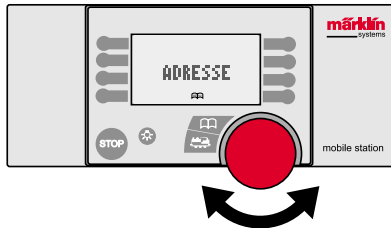

⑥



⑦

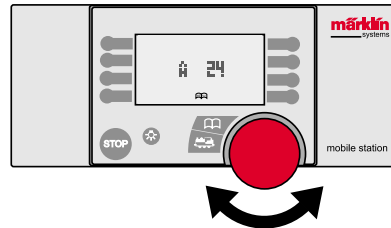

⑧

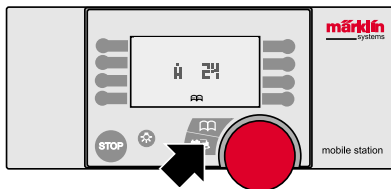

# Appendix

## G

	ON
	1 2 3 4
02	- 2 3 4
06	1 - 3 4
08	- - 3 4
18	1 2 - 4
20	- 2 - 4
24	1 - - 4
26	- - - 4
54	1 2 3 -
56	- 2 3 -
60	1 - 3 -
62	- - 3 -
72	1 2 - -
74	- 2 - -
78	1 - - -
80	1 2 3 4

Digital	ON	Digital	ON	Digital	ON
	1 2 3 4 5 6 7 8		1 2 3 4 5 6 7 8		1 2 3 4 5 6 7 8
01	- 2 3 - 5 - 7 -	28	- 2 3 - 5 - - 8	55	- 2 3 - 5 - - -
02	- - 3 - 5 - 7 -	29	- - 3 - 5 - - 8	56	- - 3 - 5 - - -
03	1 - - 4 5 - 7 -	30	1 - - 4 5 - - 8	57	1 - - 4 5 - - -
04	- 2 - 4 5 - 7 -	31	- 2 - 4 5 - - 8	58	- 2 - 4 5 - - -
05	- - - 4 5 - 7 -	32	- - - 4 5 - - 8	59	- - - 4 5 - - -
06	1 - - - 5 - 7 -	33	1 - - - 5 - - 8	60	1 - - - 5 - - -
07	- 2 - - 5 - 7 -	34	- 2 - - 5 - - 8	61	- 2 - - 5 - - -
08	- - - 5 - 7 -	35	- - - 5 - - 8	62	- - - 5 - - -
09	1 - 3 - - 6 7 -	36	1 - 3 - - 6 - 8	63	1 - 3 - - 6 - -
10	- 2 3 - - 6 7 -	37	- 2 3 - - 6 - 8	64	- 2 3 - - 6 - -
11	- - 3 - - 6 7 -	38	- - 3 - - 6 - 8	65	- - 3 - - 6 - -
12	1 - - 4 - 6 7 -	39	1 - - 4 - 6 - 8	66	1 - - 4 - 6 - -
13	- 2 - 4 - 6 7 -	40	- 2 - 4 - 6 - 8	67	- 2 - 4 - 6 - -
14	- - - 4 - 6 7 -	41	- - - 4 - 6 - 8	68	- - - 4 - 6 - -
15	1 - - - 6 7 -	42	1 - - - 6 - 8	69	1 - - - 6 - -
16	- 2 - - - 6 7 -	43	- 2 - - - 6 - 8	70	- 2 - - - 6 - -
17	- - - - 6 7 -	44	- - - - 6 - 8	71	- - - - 6 - -
18	1 - 3 - - - 7 -	45	1 - 3 - - - 8	72	1 - 3 - - - -
19	- 2 3 - - - 7 -	46	- 2 3 - - - 8	73	- 2 3 - - - -
20	- - 3 - - - 7 -	47	- - 3 - - - 8	74	- - 3 - - - -
21	1 - - 4 - - 7 -	48	1 - - 4 - - 8	75	1 - - 4 - - -
22	- 2 - 4 - - 7 -	49	- 2 - 4 - - 8	76	- 2 - 4 - - -
23	- - - 4 - - 7 -	50	- - - 4 - - 8	77	- - - 4 - - -
24	1 - - - - 7 -	51	1 - - - - 8	78	1 - - - - -
25	- 2 - - - - 7 -	52	- 2 - - - - 8	79	- 2 - - - - -
26	- - - - - 7 -	53	- - - - - 8	80	1 - 3 - 5 - 7 -
27	1 - 3 - 5 - - 8	54	1 - 3 - 5 - - -		



## Appendix

# H

Only locomotives that can be coded electronically.

②

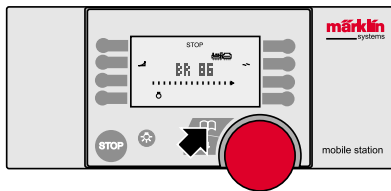

③

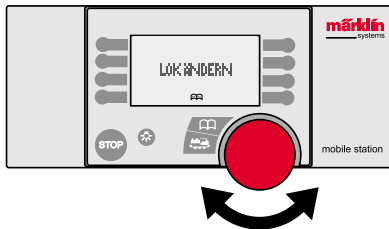

④

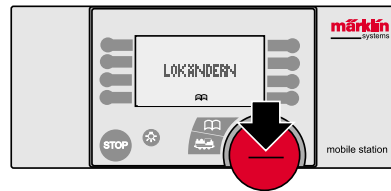

⑤

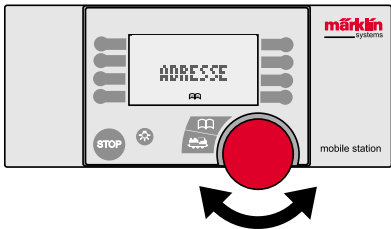

⑥

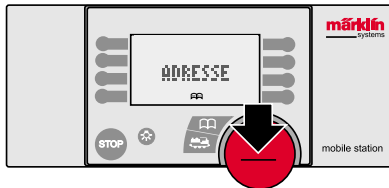

⑦

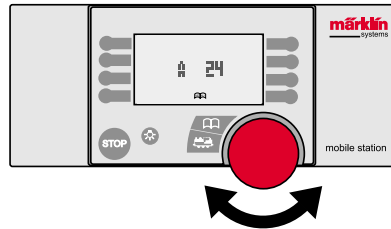

⑧

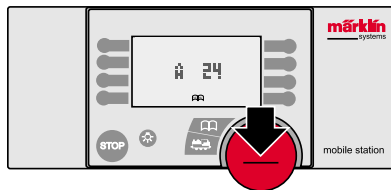

⑨

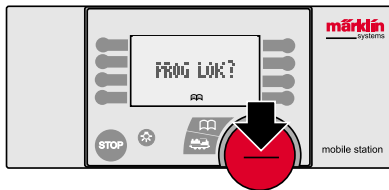

# Appendix

I



# Appendix

## J

①

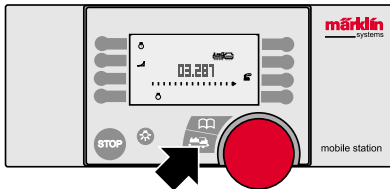

②

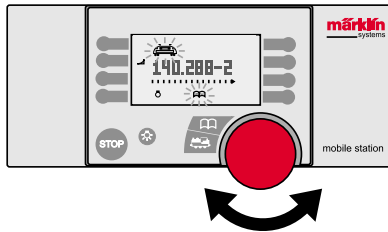

③

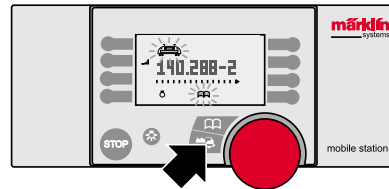

④

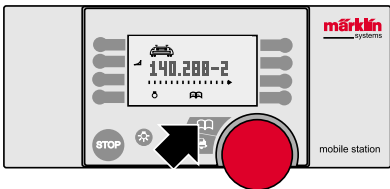

⑤

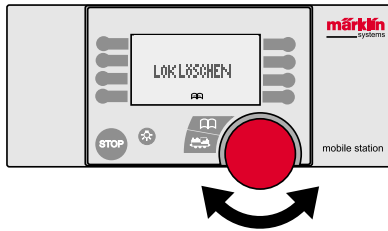

⑥

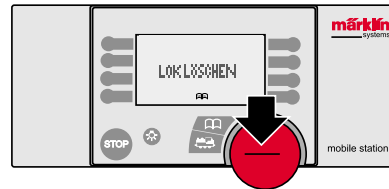

⑦

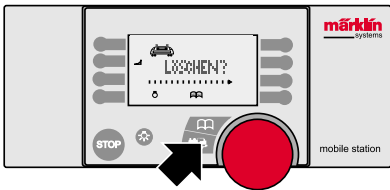

# Appendix

## K



# Appendix

## L

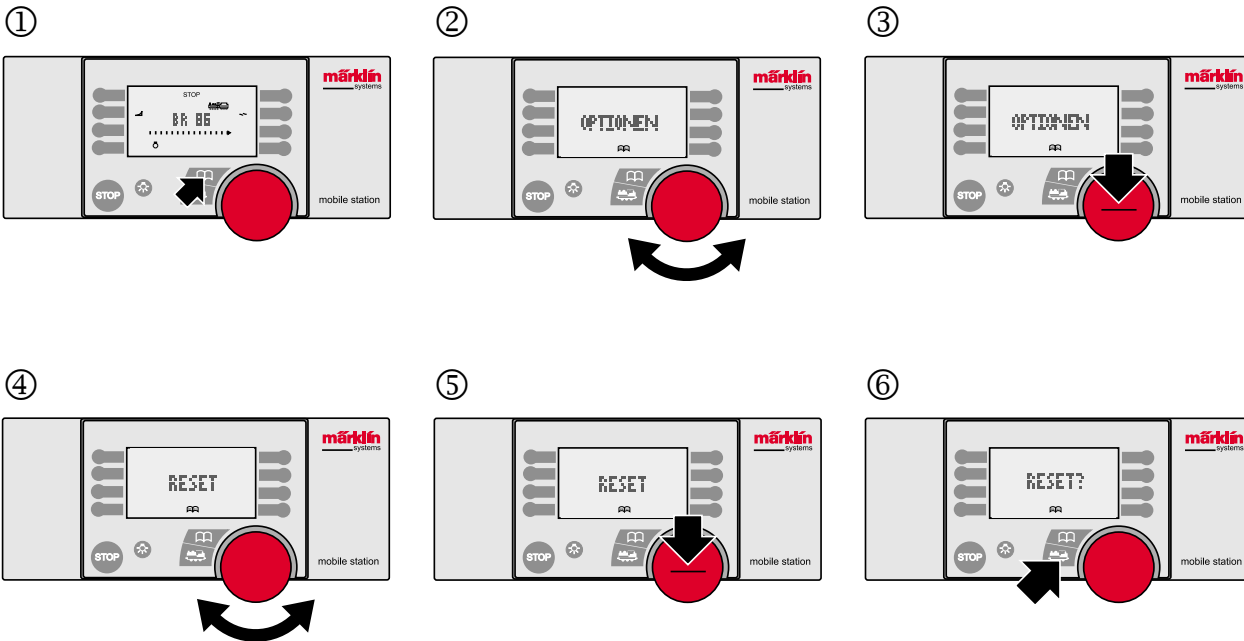

# Appendix

## M

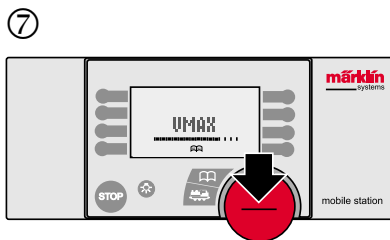
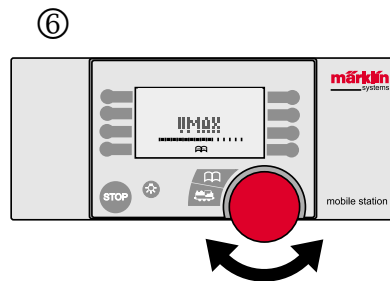
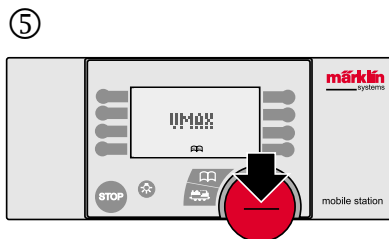
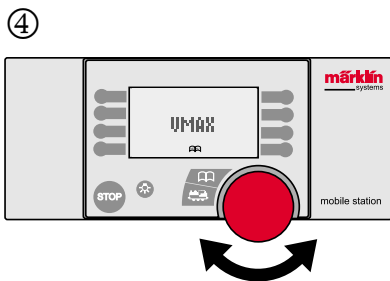
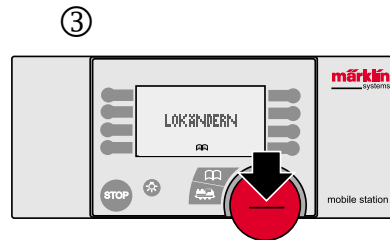
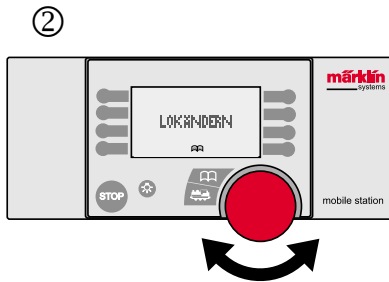
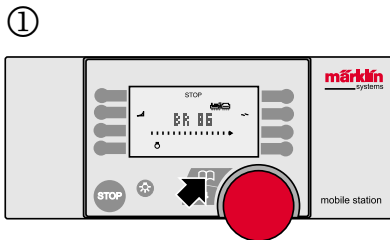

# N

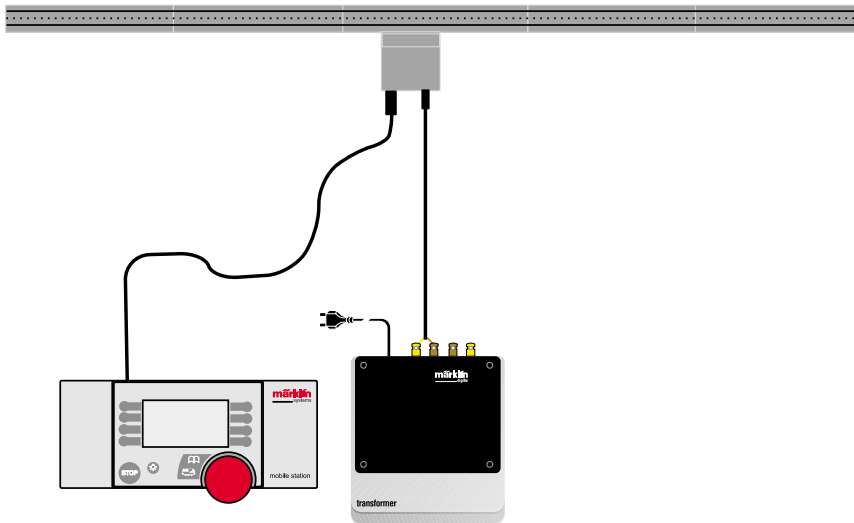
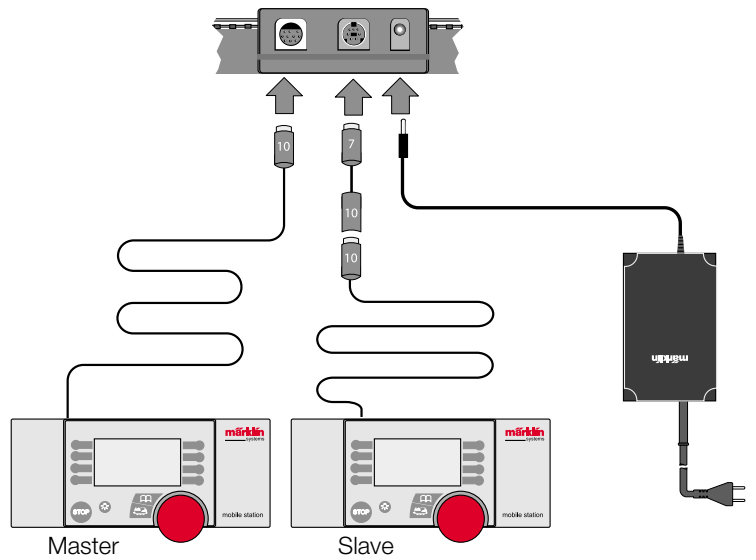

# Appendix

## O

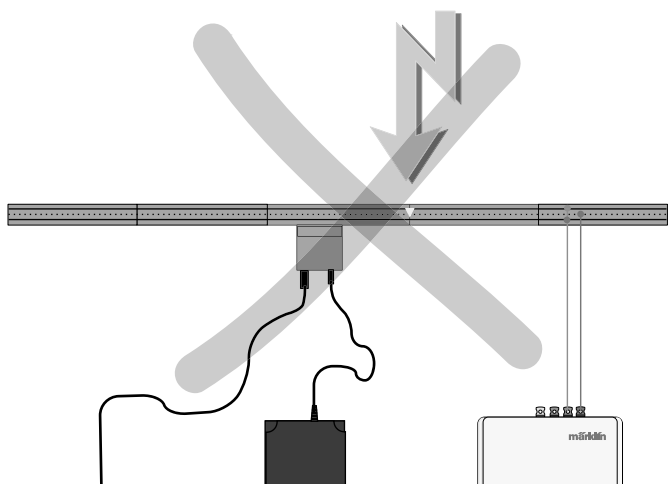
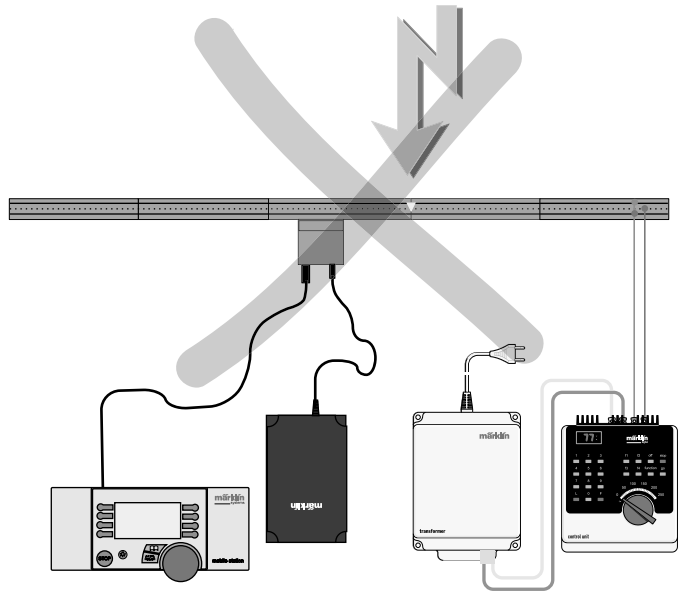



## Table of Explanations for Functions on Display Screen

<b>Deutsch</b>	<b>Englisch</b>	<b>Français</b>	<b>Nederlands</b>
NEUE LOK	NEW LOC	NOUV. LOC	NIEUWE LOC
LOKÄNDERN	EDIT LOC	MODIF LOC	WYZIG LOC
LOKLÖSCHEN	DELETE LOC	SUPPR LOC	LOC WISSEN
LOKLÖSCHEN?	DELTE LOC?	SUPPR LOC?	LOC WISSEN?
OPTIONEN	SETUP	OPTIONS	OPTIES
DATENBANK	DATABASE	BANQUE LOC	DATABANK
ADRESSE	ADDRESS	ADRESSE	ADRES
SPEICHERN	SAVING	ENREGISTR	OPSLAAN
ADR.FEHLER	ADDR.USED	ERREUR ADR	ADR.INGEBR
NAME	NAME	NOM	NAAM
VMAX	VMAX	VMAX	MAX.SNELH.
ACC	ACC	ACC	OPTREKKEN
DEC	DEC	DEC	AFREMMEN
RESET	PRESET	RESET	BASIS INST
LOKAKTIV	LOC USED	LOC ACTIVE	LOC INGEBR
LÖSCHEN?	DELETE?	SUPPR?	WISSEN?
SPRACHE	LANGUAGE	LANGUE	TAAL
INFO	INFO	INFO	INFO
DEUTSCH	ENGLISCH	FRANCAIS	NEDERLANDS
VOL	VOL	VOL	VOL
PROG	PROG	PROG	PROG
PROG LOK?	PROG LOC?	PROG LOC?	PROG LOC?
ZENTRALE	CENTRAL	CENTRALE	CENTRALE
KEIN MASTER	NO MASTER	DEVIENT ESCLAVE	GEEN MASTER
SYMBOL?	SYMBOL?	TYPE DE LOCO?	SYMBOOL?
KEINE LOK	NO LOC	PAS DE LOC	GEEN LOC
LISTE VOLL	LIST FULL	LISTE PLEINE	LIJST VOL

## Table of Explanations for Functions on Display Screen

<b>Español</b>	<b>Italiano</b>	<b>Svenska</b>	<b>Dansk</b>
NEW LOC	NEW LOC	NEW LOC	NEW LOC
EDIT LOC	EDIT LOC	EDIT LOC	EDIT LOC
DELETE LOC	DELETE LOC	DELETE LOC	DELETE LOC
DELTE LOC?	DELTE LOC?	DELTE LOC?	DELTE LOC?
SETUP	SETUP	SETUP	SETUP
DATABASE	DATABASE	DATABASE	DATABASE
ADDRESS	ADDRESS	ADDRESS	ADDRESS
SAVING	SAVING	SAVING	SAVING
ADDR.USED	ADDR.USED	ADDR.USED	ADDR.USED
NAME	NAME	NAME	NAME
VMAX	VMAX	VMAX	VMAX
ACC	ACC	ACC	ACC
DEC	DEC	DEC	DEC
PRESET	PRESET	PRESET	PRESET
LOC USED	LOC USED	LOC USED	LOC USED
DELETE?	DELETE?	DELETE?	DELETE?
LANGUAGE	LANGUAGE	LANGUAGE	LANGUAGE
INFO	INFO	INFO	INFO
ENGLISCH	ENGLISCH	ENGLISCH	ENGLISCH
VOL	VOL	VOL	VOL
PROG	PROG	PROG	PROG
PROG LOC?	PROG LOC?	PROG LOC?	PROG LOC?
CENTRAL	CENTRAL	CENTRAL	CENTRAL
NO MASTER	NO MASTER	NO MASTER	NO MASTER
SYMBOL?	SYMBOL?	SYMBOL?	SYMBOL?
NO LOC	NO LOC	NO LOC	NO LOC
LIST FULL	LIST FULL	LIST FULL	LIST FULL

This device complies with Part 15 of the FCC Rules.  
Operation is subject to the following two conditions:  
(1) This device may not cause harmful interference, and  
(2) this device must accept any interference received, including  
interference that may cause undesired operation.